

CATALOG
PRODUCTS
AND SERVICES

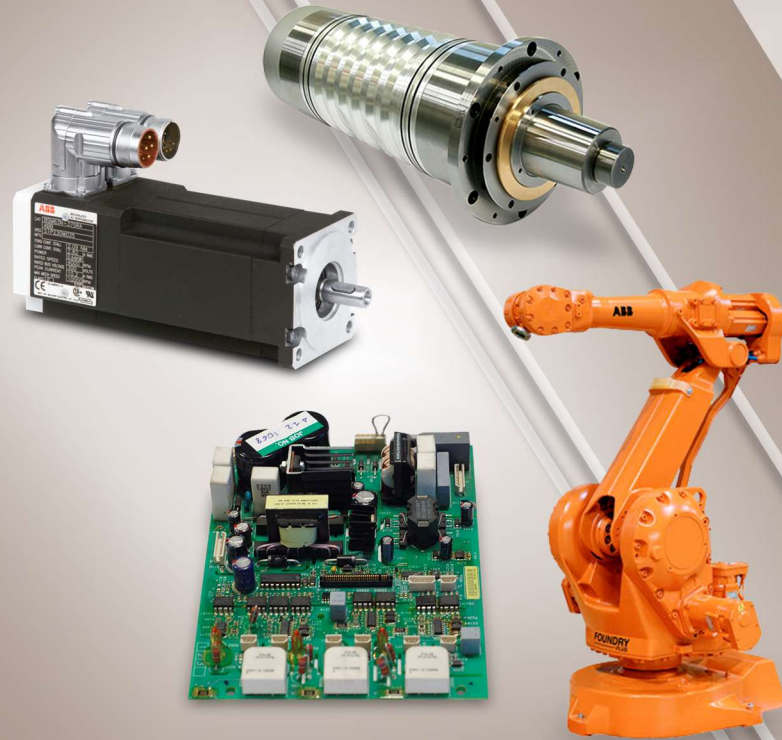

CONTROL & MOTION
GENERAL DRIVER MOTOR

Giving Solutions!



servo motors



Our value proposition

All devices can be repaired.



spindles



robotics industrial

We are the solution in the repair and remanufacturing of servomotors, industrial robotics, industrial electronics and industrial electronics and spindles



electronics industrial

Servo motors

Customers around the world choose General Driver Motor because of the reliability and trust we offer.

We recommend regular preventive maintenance to ensure optimal life of your equipment.

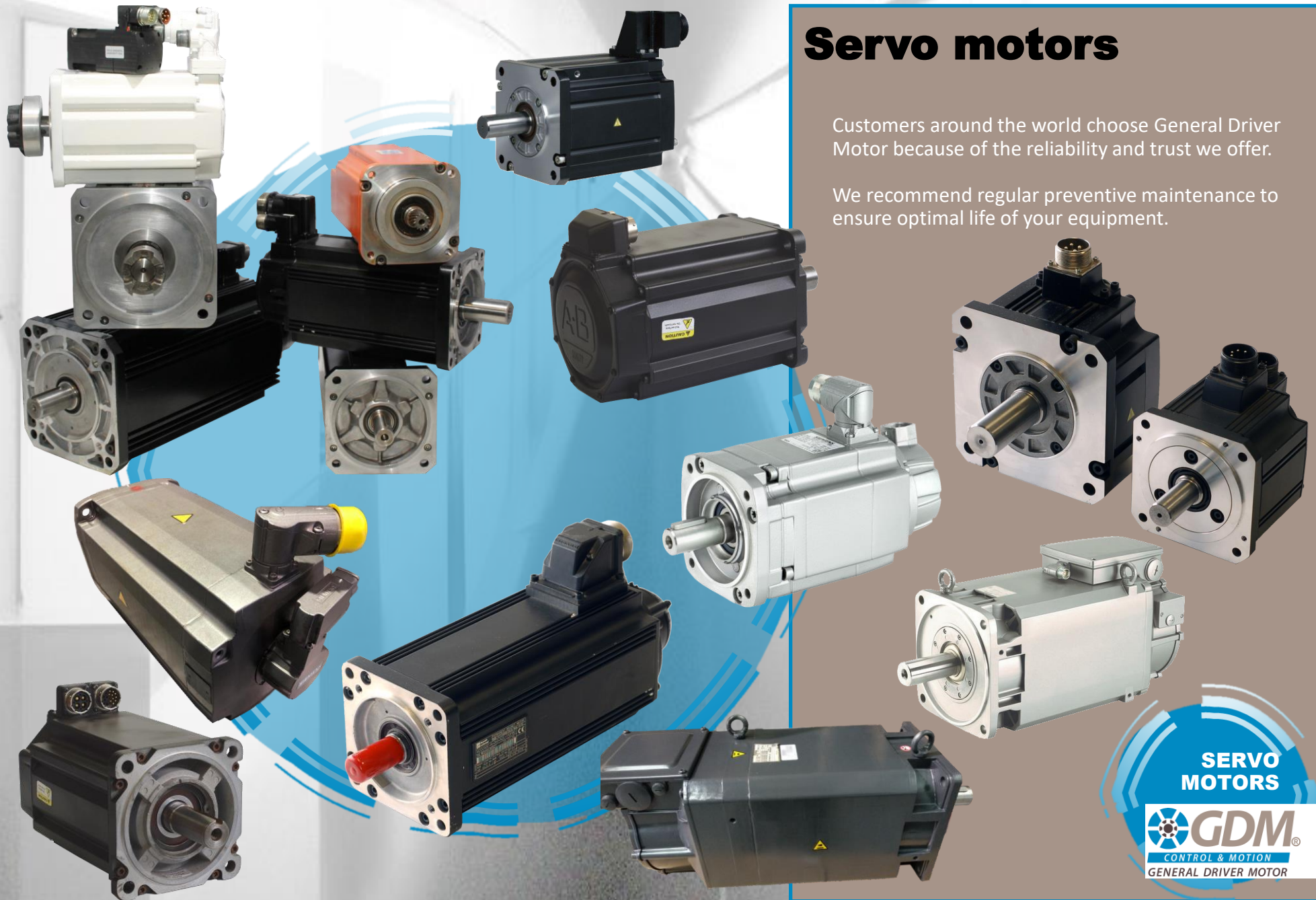

**SERVO
MOTORS**



Tests on servo motors

- Feedback devices: OEM replacement encoders.
- Test and diagnostic analysis of serial, incremental (TTL-IVPP-HTL) and absolute (Hiperface, Endat, SSI) encoders.
- Test and diagnostic analysis of resolvers.
- Test and diagnosis Hall Effect and cue.
- BFL fault locator for analog and digital circuits.
- Tektronic system, IGBT test, thyristor etc. (power).
- Test in circuit ABI.
- BGA reballing welding robot.
- Multiple instrumentation station – servomotor test – “electronic commutation signal alignment”.
- Driver control test benches.
- Brushless-servomotor test benches with Nm torque transducer.
- Temperature, vibration, static and dynamic balanced detector.
- SCHENCK SMART BALANCER test
- Baker ST 203 “stator” winding insulation test.
- Dielectric test TecnoLab RD 6.
- Test and measurement of the "rotor" magnetic field.
- Various oscilloscopes, multimeters, power supplies, function generator, SMD soldering stations, etc.
- Kuka test bench robots – ABB.
- FANUC, SIEMENS, B&R, INDRAMAT AND BOSCH CNC test benches.
- AC / DC drive test benches – 100KW.
- Technicians and engineers with experience (minimum 10 years).
- In the design and implementation process for subsequent ISO 9001:2000 certification.
- Final check and verification reports.
- General test specifications.

Servo motors

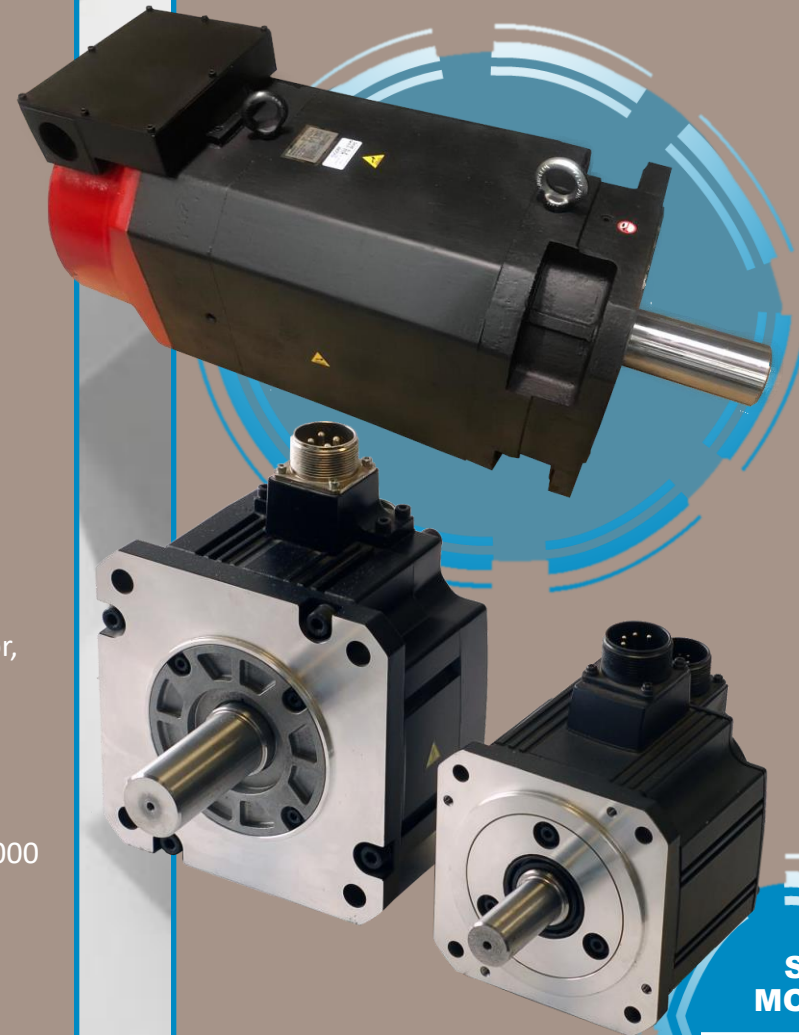

**SERVO
MOTORS**



Spindles

At GDM, we repair spindles, electrospindles, spindles, high-rev motors, and special motors.

Spindles or electrospindles are our specialty, and our clients are totally satisfied with our services. At GDM we have a large stock of spare parts in order to offer a fast and quality repair. And above all fast, being at the forefront of market response time.

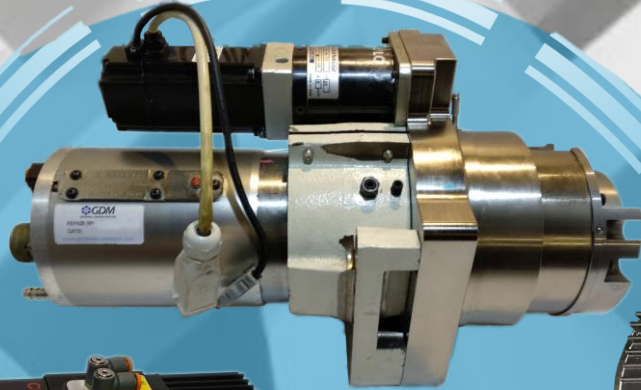

SPINDLES



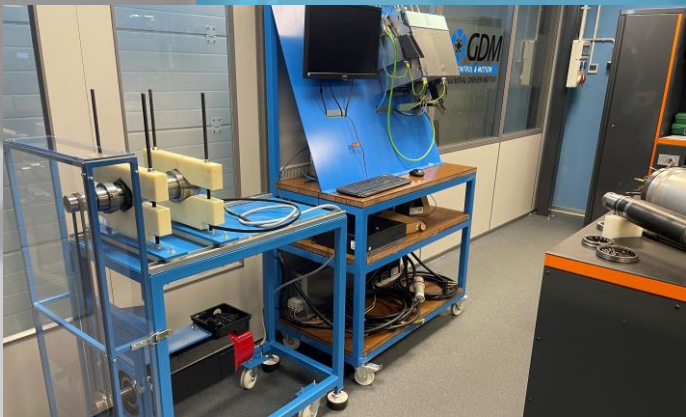
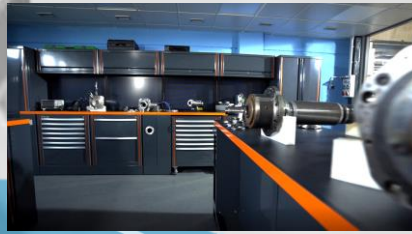

Our spindle repair room

We continue to invest to improve our facilities.

Room designed to repair spindles and special motors. Our room has temperature control and suspended particles.

The room has a measurement column, as well as test benches specially designed for spindles. This allows us to test and verify all our repairs, which guarantees the quality of our final finishes.

It is also equipped with a dynamic balancing system and a thermal imager.

We work with the most important brands of spindles:

TIE BOHRTECHNIK, HELLER, MAXIA, KENTURN, MCFV, OMLAT, IBAG, SCM, WEISS, MIKRON, GEMINI, GANFIOR, HSD, FRANK KESSLER, G. COLOMBO, CMS, TDM, HERMLE, GMN, HDS, HSK, HQD, CAPELLINI, SIEMENS, DMG MORI, UMBRA, CYTEC, SPIN-UP, PHASE, ALFRED JAGER, FICHER AE, SPAT, BROTHER, PERSKE, HARDY, SACCARDO, BUSELLATO, BREMBANA MACHINE, STAMA, KAISER, PRECISE, ELTE, EMAG, SACO, KAVO, COSMEC, VIMO, HITECO, VEM, FS, WANETIANNAN, CELLS, FPT, FANUC...





Robotics industrial

Since every problem is different, each method is uniquely tailored to your needs.

We put at your disposal a team of experts to respond to any incident.

- > Portable consoles.
- > servo controllers
- > processor panels.
- > Servo processor panels.
- > Security panels.
- > System I/O panels.
- > Network interface panels.
- > Power sources.



**ROBOTICS
INDUSTRIAL**

GDM
CONTROL & MOTION
GENERAL DRIVER MOTOR

Electronics industrial

Each new challenge translates into research, learning and development. Meticulous planning and strict control guarantee the quality of our work.

We have an electronic repair laboratory with more than 150 test benches, its modern testing systems locate any fault, which guarantees the repair or remanufacturing of:

- > ENCODERS.
- > POWER SUPPLIES.
- > STARTERS.
- > DRIVERS CONTROL.
- > FREQUENCY INVERTERS.
- > CONTROL PANELS.
- > TOUCH SCREENS.



ELECTRONICS INDUSTRIAL



GDM
CONTROL & MOTION
GENERAL DRIVER MOTOR



Electronics industrial

Our industrial electronics department guarantees equipment repairs. Our more than 150 test benches help us in this work, from the controlcheck department.

After the repair, the equipment returns to the control check department, where a verification of the repair will be carried out. In this test, a video and a photographic report are made that record the operation of the device. In addition, a record of measurements and signals from the different tests is documented. The equipment will undergo a series of variable load tests. In this way we can guarantee the perfect state of operation from the quality control of the repair.

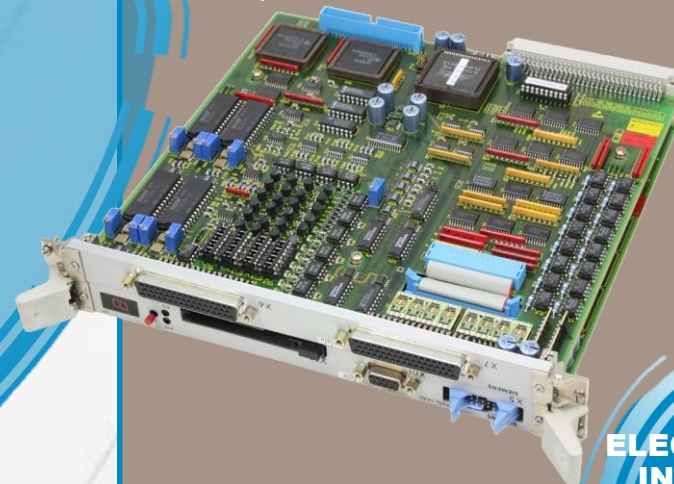

**ELECTRONICS
INDUSTRIAL**



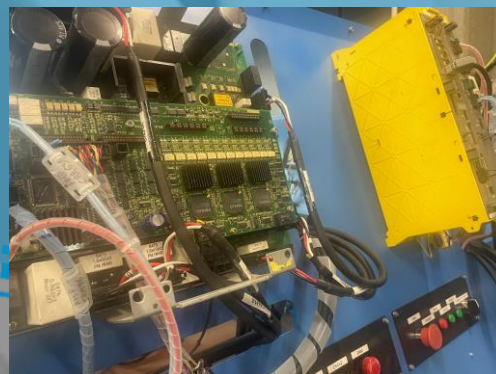

Test Benches

GDM continues to progress in the commitment to quality. The investment in our test benches demonstrates this effort for a line of work in which we firmly believe.

GDM's commitment to provide solutions to our customers in any brand on the market has led us to the need for a strong investment in test benches. Currently our company has more than 150 test benches. Without a doubt, this is one of our potentials that allows us to give a very high level of quality in our repairs.

The tests carried out on the final test bench guarantee the reliability of the repair. But not only that, but they also allow you to check the fault before proceeding with the repair.

Our controlcheck department relies on these banks to carry out correct testing work, guaranteeing the excellence of the repair.





**GDM,
GIVING SOLUTIONS!**

Preventive Maintenance

We recommend regular preventive maintenance to ensure optimal life of your equipment. Customers around the world choose General Driver Motor because of the reliability and trust we offer.

- > Feedback devices: OEM replacement encoders.
- > Test and diagnostic analysis of resolvers.
- > Test and diagnosis Hall Effect and cue.
- > Multiple instrumentation station – servomotor test – “electronic commutation signal alignment”.
- > Brushless-servomotor test benches with Nm torque transducer.
- > Temperature, vibration, static and dynamic balanced detector.
- > SCHENCK SMART BALANCER test.
- > Insulation test - Baker ST 203 "stator" winding.
- > Dielectric test TecnoLab RD 6.
- > Test and measurement of the "rotor" magnetic field.

Our team is your best ally to develop preventive maintenance plans for your servo systems. Our objective is clear, giving solutions.





Immediate replacement stock

In addition to our repair and remanufacturing capabilities. Not only in the field of corrective maintenance, but also preventive.

We add a stock to minimize our response times as much as possible.

We have more than 500 servomotors and electronic devices for immediate replacement.

MORE THAN 500 REPLACEMENT EQUIPMENTS

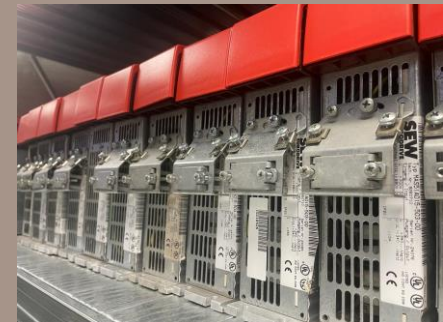

IMMEDIATE
STOCK





HIWIN®

Motion Control and System Technology

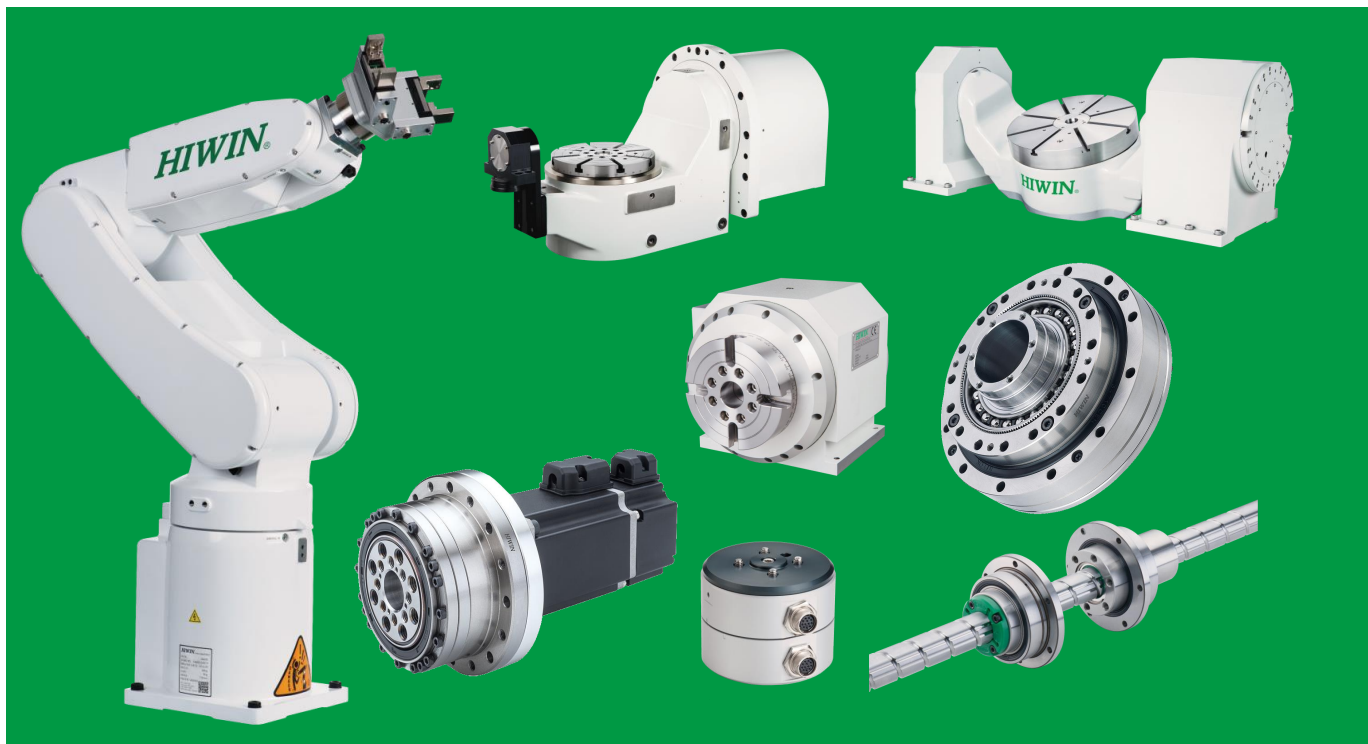

CONTROL & MOTION
GENERAL DRIVER MOTOR

Giving Solutions!

PRODUCT CATALOG 2023

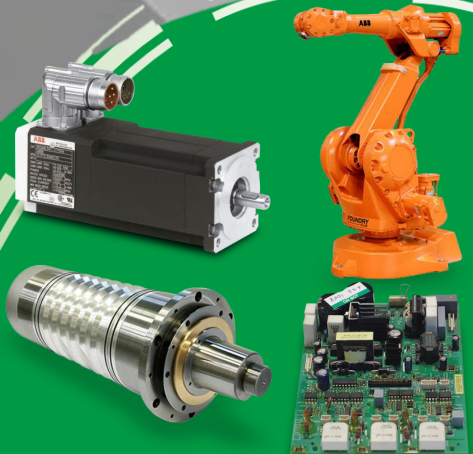

Thinking in the future

With the commitment to expand and improve our services

A new activity is added to GDM's portfolio



We introduce a new brand

Official distributor for Spain and Portugal of

HIWIN®



CONTROL & MOTION
GENERAL DRIVER MOTOR

Official distributor for Spain and Portugal

We are distributors of the
Taiwanese multinational
company's products

HIWIN®
Motion Control and System Technology

We are expanding our offer

New products at the
highest level



Commitment to dedication and improvement

To be worthy of being
among the distributors in
Europe



A benchmark in industrial automation

High quality products and
services



Different devices in stock

Attention in the shortest
time and with the highest
quality



HIWIN®

Motion Control and System Technology

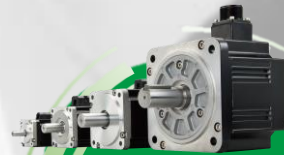

SERVOS

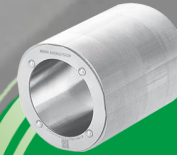

SPINDLES

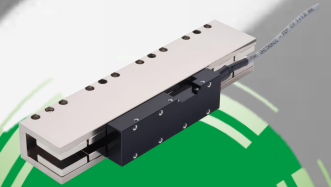

**LINEAR
AUTOMATION**

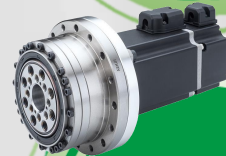

**TORQUE
MOTOR**



ROBOTS



**ROTARY
TABLE**



BEARING



**LINEAR
MOVEMENT**

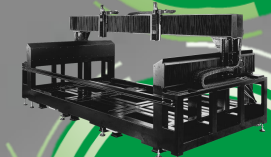

**AD HOC
PROJECTS**



CONTROL & MOTION
GENERAL DRIVER MOTOR

Giving Solutions!

AC Servo Motor and Driver

Semiconductor / Packaging / SMT / Food Industry / LCD

- > Motors - 50W-2000W
- > Drivers-D1, D2T/D2T-LM, E1



**SERVO
AND DRIVER**



Spindle Motor IM-1 Series

The permanent magnet synchronous motor design meets the machining requirements of high torque, high speed, high precision and high cutting efficiency, which greatly reduces energy consumption.

- > Suitable for all kinds of motor built-in type of spindle axes.
- > Permanent magnet embedded rotor.
- > Balance level: G2.5
- > Max. efficiency: 96% and above.

SPINDLES

HIWIN®



Linear Motor Stage

Automated transport / AOI Application /
Precision / Semiconductor

- > With Iron Core.
- > Ironless Type.
- > Linear Turbo LMT.
- > Planar servomotor.
- > Air Bearing Platform.
- > X-Y Stage.
- > Gantry Systems.
- > Single Axis Linear Motor Stage.

LINEAR
AUTOMATION

HIWIN®





Linear Motor

Machine tool / Touch panel industry /
Semiconductor industry / Laser manufacturing
machine / Glass cutting machine.

- > Iron Core Linear Motor-LMSA, LMSA-Z,
LMFA, LMFC, LMFP series.
- > Ironless Linear Motor-LMC, LMT series.

LINEAR
AUTOMATION

HIWIN®



Linear Actuator

Hospital bed / Automatic window / Home care facility / Riveting / Press-fitting / Surface checks / Bending

- > Servo actuator - LAA series
- > LAM series > LAS series
- > LAN series
- > LAC series





Positioning Measurement System

Cutting machines / Traditional gantry milling machines / Programmable drilling machines

- > High Resolution.
- > Signal translator.
- > High-precision Enclosed.
- > High Efficiency Counter.



Single-Axis Robot

Precision / Semiconductor / Medical / FPD

- > KK, SK
- > KS, KA
- > KU, KE, KC

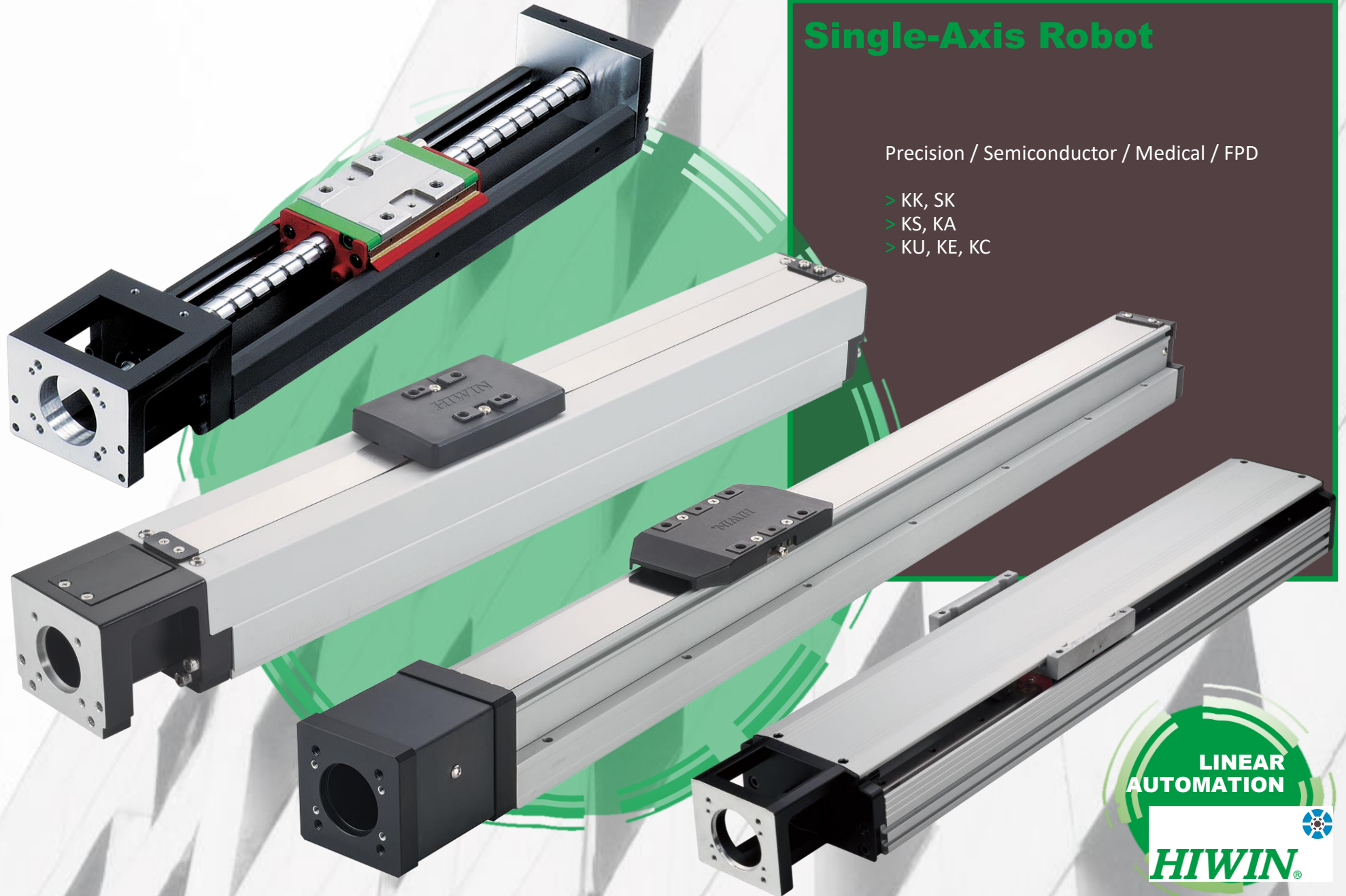

LINEAR
AUTOMATION

HIWIN



Torque Motor and Direct Driver Motor

Machine tools

> Torque Motor--TM-2/IM-2, TMRW Series

Inspection / Testing Equipment / Robot

> Direct Driver Motor--DMS, DMY, DMN, DMT Series



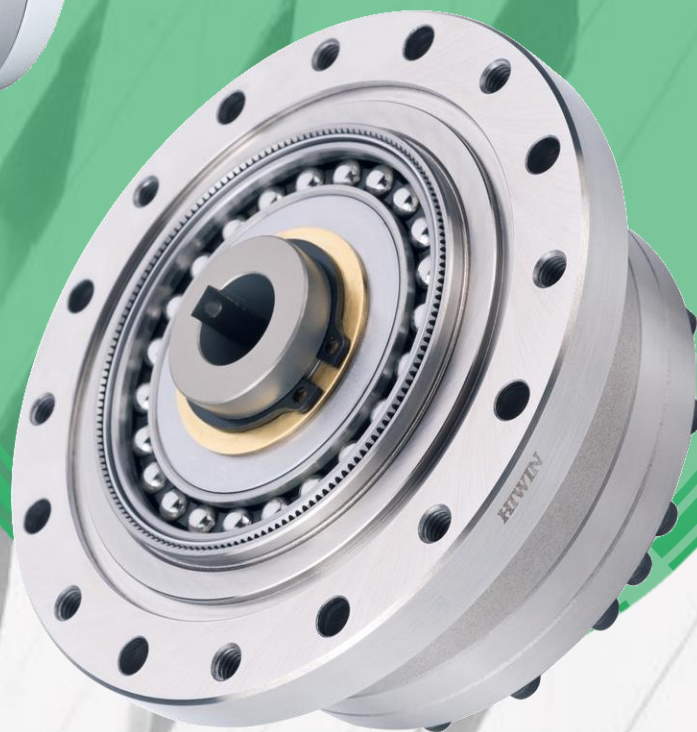
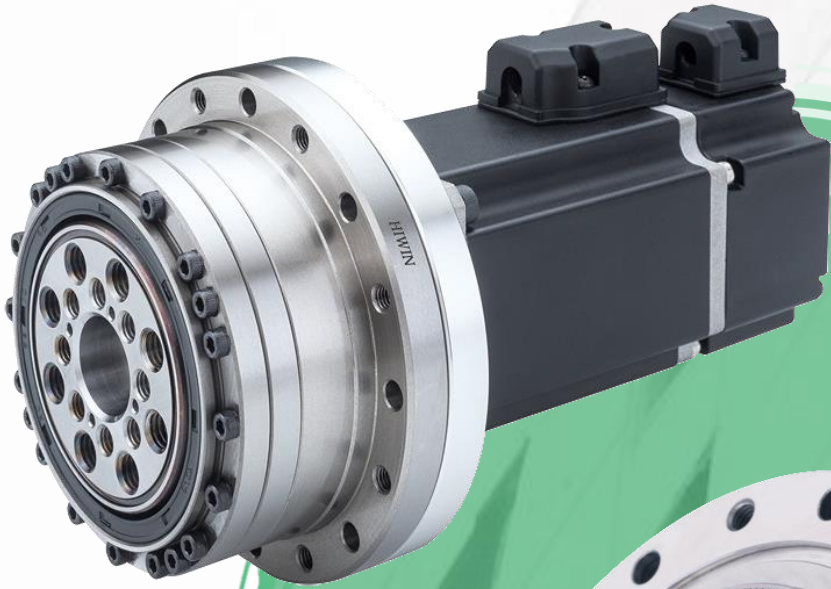

DATORKER®
Strain Wave Gear

Robot / Automation Equipment /
Semiconductor Equipment / Machine Tools

- > DSC Type
- > DSH Type
- > DRA Series





Multi-Axis Robot

Pick-and-Place / Assembly / Array and Packaging / Semiconductor / Electro-Optical Industry / Automotive Industry / Food Industry

- > Articulated Robot
- > SCARA Robot
- > Electric Gripper
- > Integrated Electric Gripper

ROBOTS

HIWIN®

Torque Motor Rotary Table

Medical / Automotive industry / Machine tools / Machinery industry

- > RAB Series
- > RAS Series
- > RCV Series
- > RCH Series



ROTARY TABLE





Bearing

Machine Tools / Robots

- > Crossed Roller Bearing
- > Ballscrew Bearing
- > Linear Bearing
- > Support Unit



Linear Guideway

Automation / Semiconductor / Medical

- > Ball Type -- HG, EG, WE, MG, CG
- > Quiet Type -- QG, QE, QW, QR
- > Other -- RG, E2, PG, SE, RC

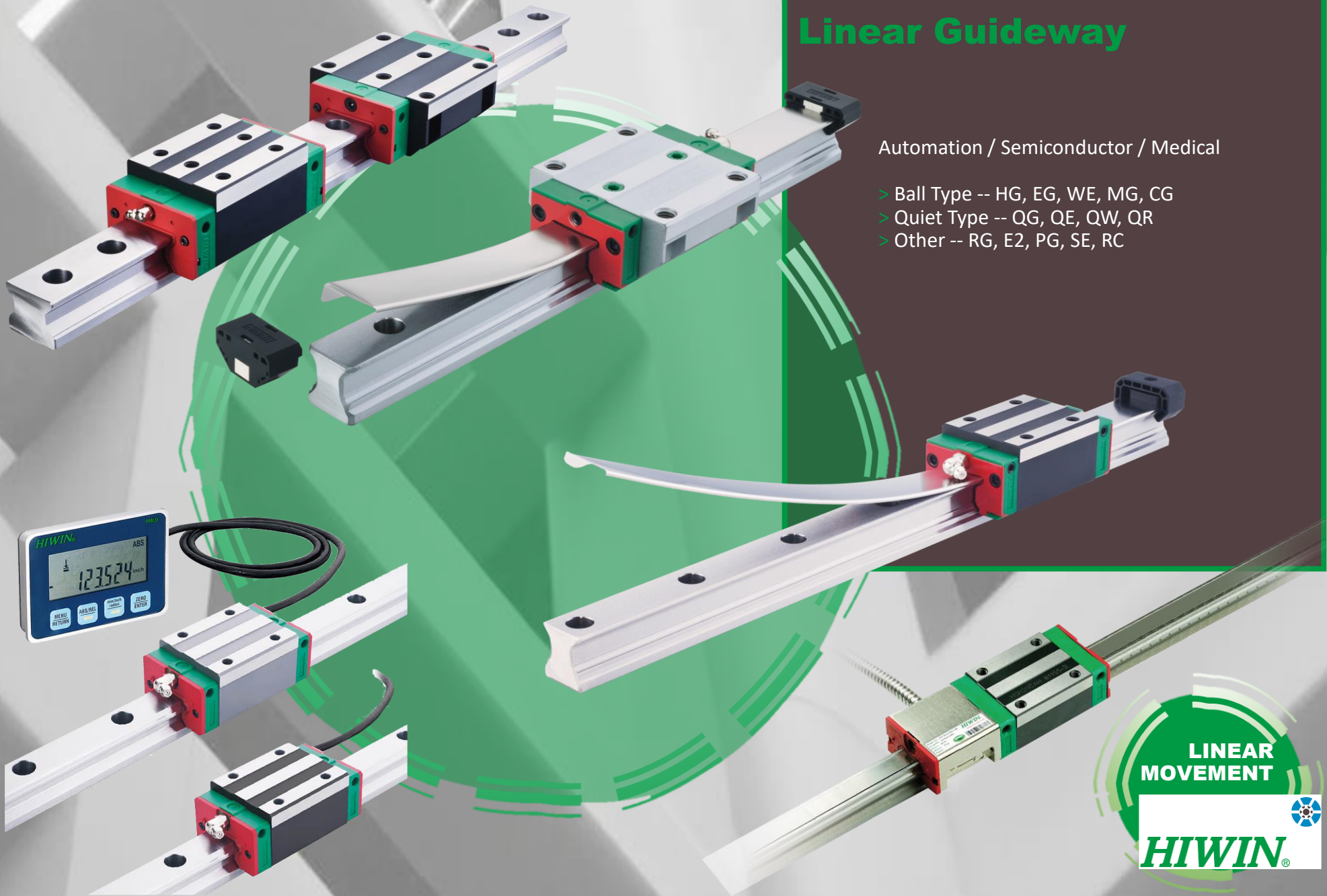

LINEAR
MOVEMENT

HIWIN®



Ballscrew

Precision Ground / Rolled

- > Super S Series
- > Super T Series
- > Mini Roller
- > Ecological and Economical Lubrication Module E2
- > Rotating Nut (R1)
- > Energy-Saving and Thermal-Controlling (Cool Type)
- > Heavy Load Series (RD)
- > Ball Spline

i4.0BS[®]

LINEAR
MOVEMENT

HIWIN[®]



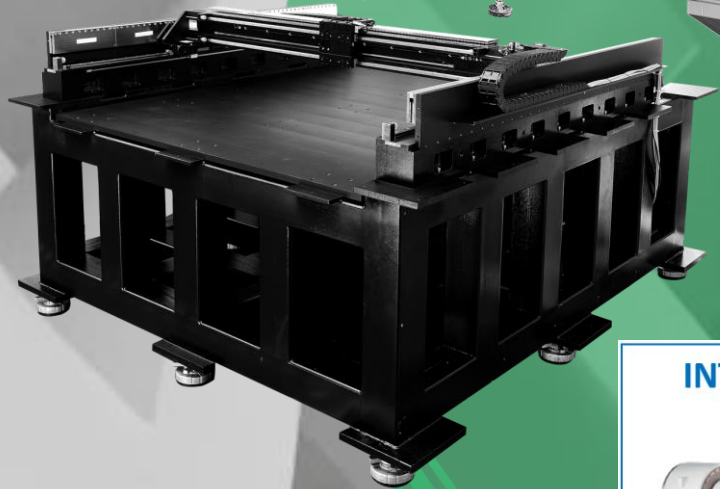
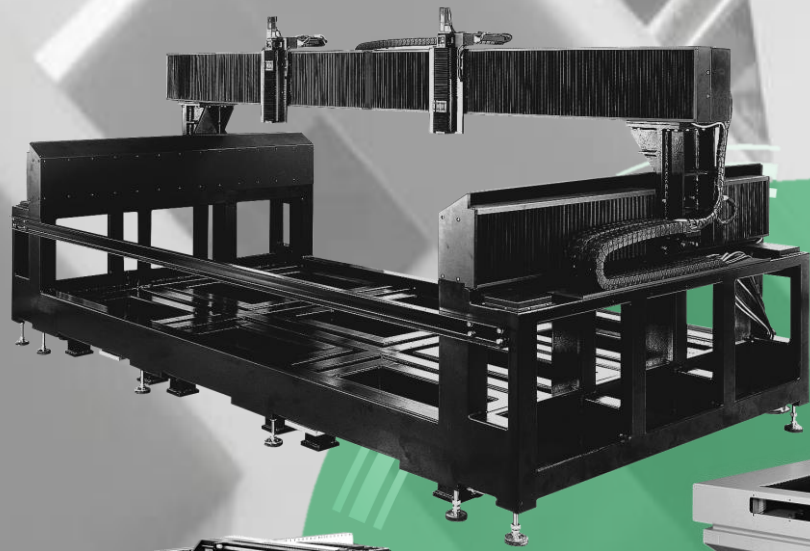

Ad hoc Projects

GDM-HIWIN master the ability of the mechatronic system integration. Provides pre-sale service to help customers for evaluation, product selection, structure testing then to the application technology exchange after sale.

GDM-HIWIN also provides total solution, uphold the spirit of manufacturing service, committed to improvement of the competitiveness of customers' machine, creating innovative value services for valued customers.

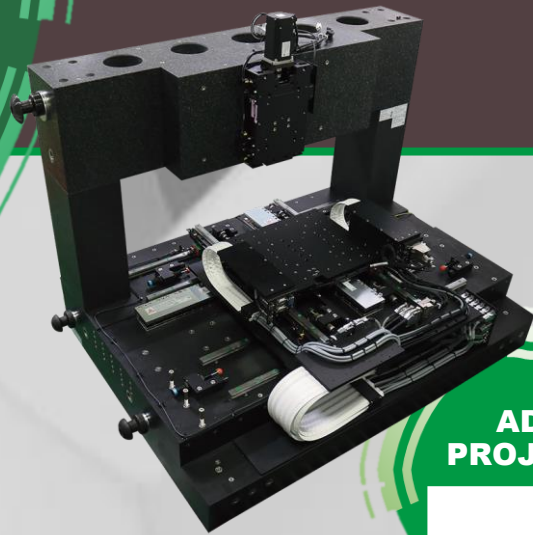

INTEGRATION SOLUTION ROTARY TABLE



**THE BEST PARTNER
OF UPGRADATION
AND TRANSFORMATION**

**AD HOC
PROJECTS**





CONTROL & MOTION

GENERAL DRIVER MOTOR

Giving Solutions!

Address:

Parque Industrial El Brizo
C/ Endrino, 129-130
47162 Aldeamayor de San Martín
Valladolid (ESPAÑA)

Phone number:

+34 983 404 304
+34 676 456 046

Email:

info@generaldrivermotor.com

Official distributor
for Spain and Portugal

HIWIN®

Motion Control and System Technology

Phone number:

+34 983 404 304
+34 691 244 656

Email:

hiwin@generaldrivermotor.com